



1945 - 2020



MHA ZENTGRAF
FlowControlTechnology



CATALOG

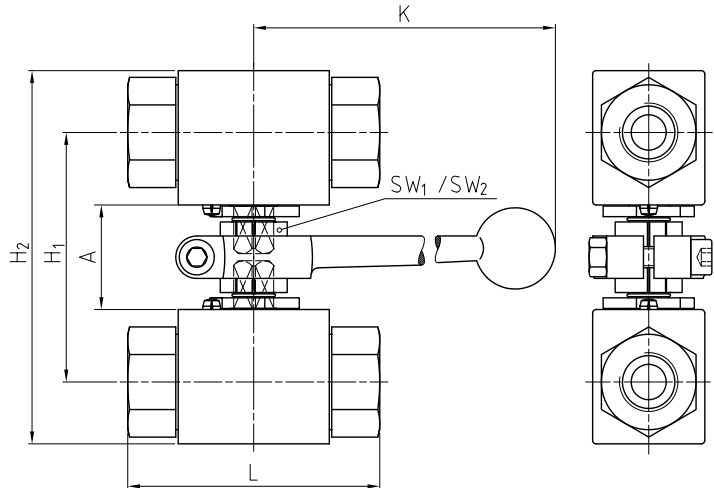

Detailed dimensions:
Catalog page 16 to 18

SW₁: Wrench size of stem
SW₂: Wrench size of lever

AVAILABLE SIZES

DN4 - DN25 (1/8" to 1")

CONNECTIONS

DIN ISO 228 Female thread, ANSI B1.20.1 NPT Female thread, DIN 2353/ISO 8434-1 Light / Heavy series, SAE J 514/ISO/DIS11926-1 Female thread, others on request

ACCESSORIES ON REQUEST



- Locking devices on request
- Actuators on request
- Mounting holes on request
- Position switches on request

MATERIAL CODE DESCRIPTION

Materials	112A
Body	Steel
Ball	Steel
Stem	Steel
Ball seats	POM
O-rings	NBR
Tmin /Tmax	-20°C / 100°C

GENERAL DIMENSIONS

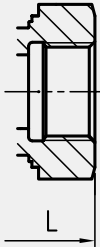
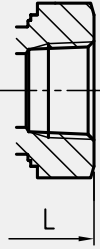
Type	SW ₁	SW ₂	A	H ₁	H ₂	K	Lever
BKH-DN4	9	14	30	69	96	200	Zn
BKH-DN6	9	14	30	69	96	200	Zn
BKH-DN8	9	14	30	69	96	200	Zn
BKH-DN10	9	14	30	71	106	200	Zn
BKH-DN13	9	14	30	72	110	200	Zn
BKH-DN16	12	17	35	89	127	320	Al
BKH-DN20	14	17	39	104	153	320	Al
BKH-DN25	14	17	39	110	169	320	Al
BKHP500-DN25	14	17	39	110	179	320	Al
BKH-DN25/32	14	17	39	110	169	320	Al
BKH-DN25/40	14	17	39	110	169	320	Al

CONNECTION TYPE	DIMENSIONS			ORDER CODE PER MATERIAL COMBINATION	
DIN ISO 228 FEMALE THREAD 	Type	L	Weight [Kg]	PN [bar]	112A
	BKH-DN4-G1/8	69	0,80	500	38806*
	BKH-DN6-G1/4	69	0,78	500	38807*
	BKH-DN10-G3/8	72	1,10	500	38808*
	BKH-DN13-G1/2	83	1,35	500	38809*
	BKH-DN16-G5/8	83	1,45	420	39240*
	BKH-DN20-G3/4	95	3,20	420	38810*
	BKH-DN25-G1	113	4,50	350	38811*
	BKHP500-DN25-G1	113	6,30	500	53493*
	BKH-DN25/32-G1 1/4	120	4,80	350	38812*
BKH-DN25/40-G1 1/2	130	5,40	350	39241*	
ANSI B1.20.1 NPT FEMALE THREAD 	Type	L	Weight [Kg]	PN [bar]	112A
	BKH-DN4-1/8"NPT	69	0,65	500	38813*
	BKH-DN6-1/4"NPT	69	0,80	500	38814*
	BKH-DN10-3/8"NPT	72	1,20	500	38815*
	BKH-DN13-1/2"NPT	83	1,52	500	38816*
	BKH-DN20-3/4"NPT	95	3,35	420	38817*
	BKH-DN25-1"NPT	113	4,80	350	38818*
	BKHP500-DN25-1"NPT	113	6,40	500	53494*
	BKH-DN25/32-1 1/4"NPT	120	5,10	350	38819*
	BKH-DN25/40-1 1/2"NPT	130	5,50	250	39242*
DIN 2353 / ISO 8434-1 LIGHT SERIES 	Type	L	Weight [Kg]	PN [bar]	112A
	BKH-DN4-6L	67	0,70	500	38790*
	BKH-DN6-8L	67	0,72	500	38791*
	BKH-DN8-10L	74	0,80	500	38792*
	BKH-DN10-12L	74	1,10	500	38793*
	BKH-DN13-15L	82	1,28	500	38794*
	BKH-DN13-18L	82	1,25	500	39244*
	BKH-DN16-18L	82	1,52	420	39245*
	BKH-DN20-22L	101	3,00	420	38795*
	BKH-DN25-28L	108	4,20	350	38796*
	BKH-DN25/32-35L	112	4,40	350	38797*
BKH-DN25/40-42L	112	4,70	350	39246*	

Please note the pressure ratings of the tube connections!

*Article usually in stock.

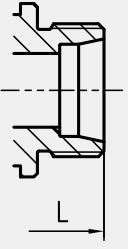
CONNECTION TYPE	DIMENSIONS			ORDER CODE PER MATERIAL COMBINATION	
	Type	L	Weight [Kg]	PN [bar]	112A
DIN 2353 / ISO 8434-1 HEAVY SERIES 	BKH-DN4-8S	73	0,72	500	38798*
	BKH-DN6-10S	73	0,76	500	38799*
	BKH-DN8-12S	76	0,76	500	38800*
	BKH-DN10-14S	80	1,10	500	38801*
	BKH-DN13-16S	86	1,25	500	38802*
	BKH-DN13-20S	90	1,25	500	39248*
	BKH-DN16-20S	90	1,68	420	39249*
	BKH-DN20-25S	109	3,20	420	38803*
	BKH-DN25-30S	120	4,30	350	38804*
	BKHP500-DN25-30S	130	6,22	500	53495*
	BKH-DN25/32-38S	124	4,70	350	38805*

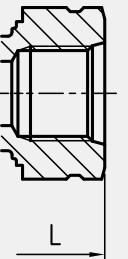
CONNECTION TYPE	DIMENSIONS			ORDER CODE PER MATERIAL COMBINATION	
	Type	L	Weight [Kg]	PN [bar]	112A
SAE J514/ISO/DIS11926-1 FEMALE THREAD 	BKH-DN6-7/16"UNF	69	0,78	500	38820*
	BKH-DN10-9/16"UNF	72	0,96	500	38821*
	BKH-DN13-3/4"UNF	83	1,42	500	38822*
	BKH-DN20-1 1/16"UN	95	3,20	420	38823*
	BKH-DN25-1 5/16"UN	113	4,60	350	38824*
	BKHP500-DN25-1 5/16"UN	121	6,32	500	53496*

Please note the pressure ratings of the tube connections!

*Article usually in stock.

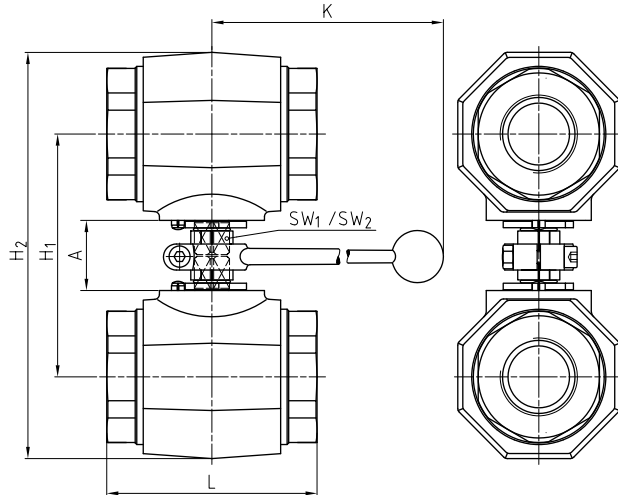

Detailed dimensions:
Catalog page 24 to 26

SW₁: Wrench size of stem
SW₂: Wrench size of lever

AVAILABLE SIZES

DN32 - DN50 (1 1/4" to 2")

CONNECTIONS

DIN ISO 228 Female thread, ANSI B1.20.1 NPT Female thread, DIN 2353/ISO 8434-1 Light / Heavy series, SAE J 514/ISO/DIS11926-1 Female thread, others on request

ACCESSORIES ON REQUEST



- Locking devices on request
- Actuators on request
- Mounting holes on request
- Position switches on request

MATERIAL CODE DESCRIPTION

Materials	112A
Body	Steel
Ball	Steel
Stem	Steel
Ball seats	POM
O-rings	NBR
Tmin /Tmax	-20°C / 100°C

GENERAL DIMENSIONS

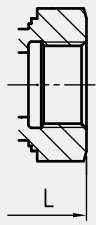
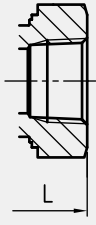
Type	SW ₁	SW ₂	A	H ₁	H ₂	K	Lever
MKHP420-DN32	17	19	43	134	215	320	Al
MKHP420-DN40	17	19	43	149	249	320	Al
MKHP420-DN50	17	19	43	159	277	320	Al

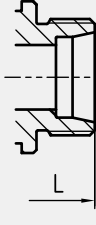
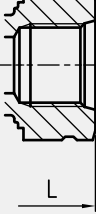
CONNECTION TYPE	DIMENSIONS			ORDER CODE PER MATERIAL COMBINATION	
	Type	L	Weight [Kg]	PN [bar]	112A
	MKHP420-DN32-G1 1/4	111	6,84	420	46217*
	MKHP420-DN40-G1 1/2	130	11,18	420	38829*
	MKHP420-DN50-G2	140	15,98	420	38830*
	Type	L	Weight [Kg]	PN [bar]	112A
	MKHP420-DN32-1 1/4"NPT	120	7,04	420	38831*
	MKHP420-DN40-1 1/2"NPT	130	11,38	420	38832*
	MKHP420-DN50-2"NPT	140	15,98	420	38833*
	Type	L	Weight [Kg]	PN [bar]	112A
	MKHP420-DN32-35L	136	7,24	420	38825*
	MKHP420-DN40-42L	147	11,08	420	38826*
	Type	L	Weight [Kg]	PN [bar]	112A
	MKHP420-DN32-38S	148	7,54	420	38827*
	Type	L	Weight [Kg]	PN [bar]	112A
	MKHP420-DN32-1 5/8"UN	111	7,04	420	38834*
	MKHP420-DN40-1 7/8"UN	130	11,38	420	38835*
	MKHP420-DN50-2 1/2"UN	140	15,98	420	38836*

Please note the pressure ratings of the tube connections!

*Article usually in stock.

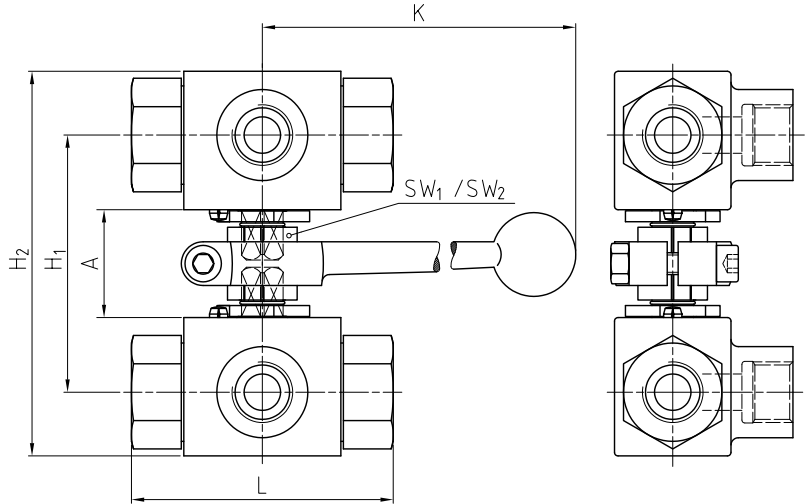

Detailed dimensions:
Catalog page 94 to 97

SW₁: Wrench size of stem
SW₂: Wrench size of lever

**! Pressure inlet only
from center port!**

AVAILABLE SIZES

DN4 - DN25 (1/8" to 1")

CONNECTIONS

DIN ISO 228 Female thread, ANSI B1.20.1 NPT Female thread, DIN 2353/ISO 8434-1 Light / Heavy series, SAE J 514/ISO/DIS11926-1 Female thread, others on request

ACCESSORIES ON REQUEST

- Locking devices on request
- Actuators on request
- Mounting holes on request
- Position switches on request

MATERIAL CODE DESCRIPTION

Materials	112A
Body	Steel
Ball	Steel
Stem	Steel
Ball seats	POM
O-rings	NBR
Tmin /Tmax	-20°C / 100°C
Porting pattern	L=SB50



PORTING PATTERNS



Further porting patterns page 274 to 279

GENERAL DIMENSIONS

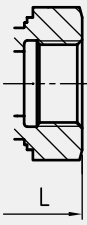
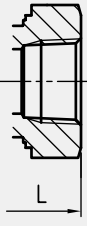
Type	SW ₁	SW ₂	A	H ₁	H ₂	K	Lever
BK3-DN4	9	14	30	69	96	200	Zn
BK3-DN6	9	14	30	69	96	200	Zn
BK3-DN8	9	14	30	69	96	200	Zn
BK3-DN10	9	14	30	71	106	200	Zn
BK3-DN13	9	14	30	72	110	200	Zn
BK3-DN20	14	17	39	104	153	320	Al
BK3-DN25	14	17	39	110	169	320	Al
BK3-DN25/32	14	17	39	110	169	320	Al

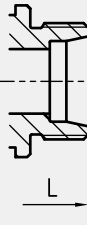
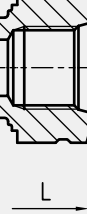
CONNECTION TYPE	DIMENSIONS			ORDER CODE PER MATERIAL COMBINATION	
	Type	L	Weight [Kg]	PN [bar]	112A L=SB50
	BK3-DN4-G1/8	69	0,78	500	38501*
	BK3-DN6-G1/4	69	0,90	500	38502*
	BK3-DN10-G3/8	72	1,25	500	20593*
	BK3-DN13-G1/2	83	1,45	500	38503*
	BK3-DN20-G3/4	95	3,68	315	33719*
	BK3-DN25-G1	113	4,90	315	38504*
	BK3-DN25/32-G1 1/4	120	5,38	315	38505*
	Type	L	Weight [Kg]	PN [bar]	112A L=SB50
	BK3-DN4-1/8"NPT	69	0,78	500	38511*
	BK3-DN6-1/4"NPT	69	0,90	500	38512*
	BK3-DN10-3/8"NPT	72	1,20	500	38513*
	BK3-DN13-1/2"NPT	83	1,40	500	38514*
	BK3-DN20-3/4"NPT	95	3,65	315	38515*
	BK3-DN25-1"NPT	113	4,90	315	38516*
	BK3-DN25/32-1 1/4"NPT	120	5,38	315	38517*
	Type	L	Weight [Kg]	PN [bar]	112A L=SB50
	BK3-DN4-6L	67	0,58	500	38486*
	BK3-DN6-8L	67	0,78	500	38487*
	BK3-DN8-10L	74	0,78	500	23786*
	BK3-DN10-12L	74	0,98	500	38488*
	BK3-DN13-15L	82	1,31	500	38489*
	BK3-DN20-22L	101	3,10	315	38490*
	BK3-DN25-28L	108	4,30	315	38491*
BK3-DN25/32-35L	112	5,20	315	38492*	
	Type	L	Weight [Kg]	PN [bar]	112A L=SB50
	BK3-DN4-8S	73	0,80	500	38493*
	BK3-DN6-10S	73	0,84	500	38494*
	BK3-DN8-12S	76	0,86	500	38495*
	BK3-DN10-14S	80	0,98	500	38496*
	BK3-DN13-16S	86	1,41	500	38497*
	BK3-DN20-25S	109	3,30	315	38498*
	BK3-DN25-30S	120	4,90	315	38499*
BK3-DN25/32-38S	124	5,70	315	38500*	
	Type	L	Weight [Kg]	PN [bar]	112A L=SB50
	BK3-DN6-7/16"UNF	69	0,98	500	38506*
	BK3-DN10-9/16"UNF	72	1,18	500	38507*
	BK3-DN13-3/4"UNF	83	1,41	500	38508*
	BK3-DN20-1 1/16"UN	95	3,70	315	38509*
	BK3-DN25-1 5/16"UN	113	5,50	315	38510*

Please note the pressure ratings of the tube connections!

*Article usually in stock.

Multiway ball valve combinations **3KH, 4KH** Steel

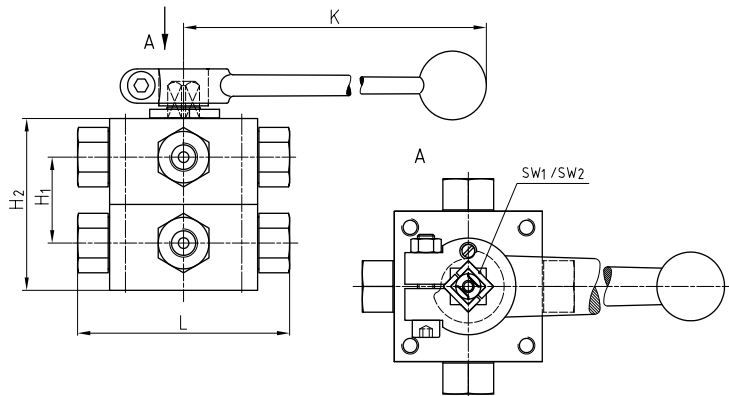

Detailed dimensions:
Catalog page 110 to 112 and 118 to 120

SW₁: Wrench size of trunnion ball
SW₂: Wrench size of lever

AVAILABLE SIZES

DN4 - DN25 (1/8" to 1")

CONNECTIONS

DIN ISO 228 Female thread, ANSI B1.20.1 NPT Female thread, DIN 2353/ISO 8434-1 Light / Heavy series, SAE J 514/ISO/DIS11926-1 Female thread, others on request

ACCESSORIES ON REQUEST

- Locking devices page 230 - 233
- Actuators 228 - 229
- Mounting holes on request
- Position switches on request
- Detent 239

MATERIAL CODE DESCRIPTION

Materials	112A	112A
Body	Steel	Steel
Trunnion ball	Steel	Steel
Ball seats	POM	POM
O-rings	NBR	NBR
Tmin / Tmax	-20°C / 100°C	-20°C / 100°C
Porting pattern	L=SB01	T=SB13
Type	3KH	4KH

GENERAL DIMENSIONS

Type	SW ₁	SW ₂	H ₁	H ₂	K	Lever
3/4KH-DN4	12	17	40	80	320	Al
3/4KH-DN6	12	17	40	80	320	Al
3/4KH-DN8	14	17	50	100	320	Al
3/4KH-DN10	14	17	50	100	320	Al
3/4KH-DN13	14	17	60	120	320	Al
3/4KH-DN16	14	17	60	120	320	Al
3/4KH-DN20	17	17	67	134	320	Al
3/4KH-DN25	17	17	82	164	320	Al
3/4KH-DN25/32	17	17	82	164	320	Al
3/4KH-DN25/40	17	17	82	164	320	Al

PORTING PATTERNS





Further porting patterns page 274 to 279

Multiway ball valve combinations

Steel

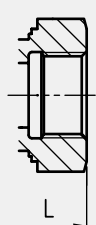
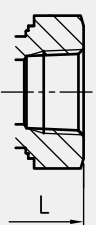
3KH, 4KH

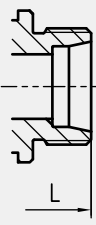
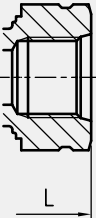
CONNECTION TYPE	DIMENSIONS			ORDER CODE PER MATERIAL COMBINATION		
	Type	L	Weight [Kg]	PN [bar]	3KH 112A L=SB01	4KH 112A T=SB13
	3/4KH-DN4-G1/8	100	3,20	500	38550	38551
	3/4KH-DN6-G1/4	100	3,20	500	19945	38552
	3/4KH-DN10-G3/8	115	5,40	500	38553	38554
	3/4KH-DN13-G1/2	136	9,80	400	19221	38555
	3/4KH-DN16-G5/8	139	9,80	400	38556	38557
	3/4KH-DN20-G3/4	154	13,40	315	38558	38559
	3/4KH-DN25-G1	172	16,60	315	38683	38684
	3/4KH-DN25/32-G1 1/4	180	17,00	315	38685	38686
3/4KH-DN25/40-G1 1/2	180	17,00	250	38687	38688	
	Type	L	Weight [Kg]	PN [bar]	3KH 112A L=SB01	4KH 112A T=SB13
	3/4KH-DN4-1/8"NPT	100	3,20	500	38689	38690
	3/4KH-DN6-1/4"NPT	100	3,20	500	38691	38692
	3/4KH-DN10-3/8"NPT	115	5,60	500	38693	38694
	3/4KH-DN13-1/2"NPT	160	10,40	400	38695	38696
	3/4KH-DN20-3/4"NPT	164	13,60	315	30805	38697
	3/4KH-DN25-1"NPT	186	17,00	315	38698	38699
	3/4KH-DN25/32-1 1/4"NPT	186	17,60	315	38700	38701
	3/4KH-DN25/40-1 1/2"NPT	186	17,60	250	38702	38703
	Type	L	Weight [Kg]	PN [bar]	3KH 112A L=SB01	4KH 112A T=SB13
	3/4KH-DN4-6L	105	3,20	500	38518	38519
	3/4KH-DN6-8L	105	3,20	500	38520	38521
	3/4KH-DN8-10L	114	5,20	500	38522	38523
	3/4KH-DN10-12L	114	5,20	500	38524	38525
	3/4KH-DN13-15L	137	9,40	400	38526	38527
	3/4KH-DN16-18L	137	9,40	400	38528	38529
	3/4KH-DN20-22L	152	13,20	315	38530	38531
	3/4KH-DN25-28L	166	16,00	315	38532	38533
3/4KH-DN25/32-35L	170	16,10	315	59591	59593	
	Type	L	Weight [Kg]	PN [bar]	3KH 112A L=SB01	4KH 112A T=SB13
	3/4KH-DN4-8S	105	3,20	500	38534	38535
	3/4KH-DN6-10S	105	3,20	500	38536	38537
	3/4KH-DN8-12S	116	5,20	500	38538	38539
	3/4KH-DN10-14S	120	5,20	500	38540	38541
	3/4KH-DN13-16S	141	9,40	400	38542	38543
	3/4KH-DN16-20S	145	9,40	400	38544	38545
	3/4KH-DN20-25S	160	13,20	315	38546	38547
	3/4KH-DN25-30S	176	16,40	315	38548	38549
3/4KH-DN25/32-38S	180	16,50	315	59595	59597	
	Type	L	Weight [Kg]	PN [bar]	3KH 112A L=SB01	4KH 112A T=SB13
	3/4KH-DN6-7/16"UNF	100	3,20	500	38704	38705
	3/4KH-DN10-9/16"UNF	115	5,60	500	38706	38707
	3/4KH-DN13-3/4"UNF	144	9,80	400	38708	38709
	3/4KH-DN20-1 1/16"UN	164	13,60	315	38710	38711
	3/4KH-DN25-1 5/16"UN	180	17,00	315	38712	38713

Please note the pressure ratings of the tube connections!

*Article usually in stock.

Multiway ball valve combinations 3KH, 4KH Steel

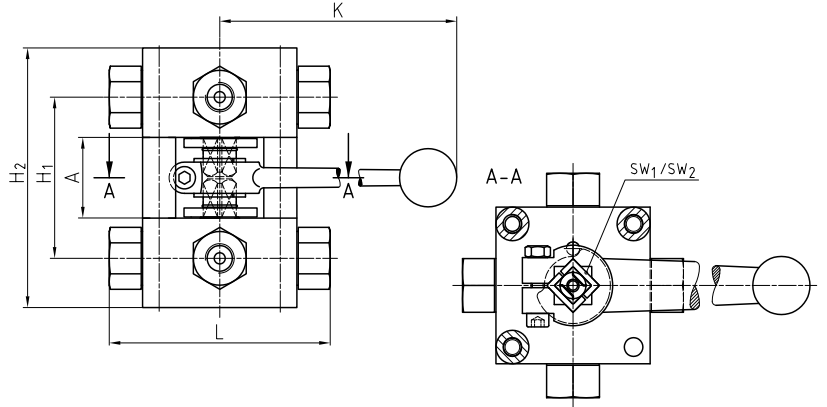

Detailed dimensions:
Catalog page 110 to 112 and 118 to 120

SW₁: Wrench size of trunnion ball
SW₂: Wrench size of lever

AVAILABLE SIZES

DN4 - DN25 (1/8" to 1")

CONNECTIONS

DIN ISO 228 Female thread, ANSI B1.20.1 NPT Female thread, DIN 2353/ISO 8434-1 Light / Heavy series, SAE J 514/ISO/DIS11926-1 Female thread, others on request

ACCESSORIES ON REQUEST

- Locking devices on request
- Actuators on request
- Mounting holes on request
- Position switches on request
- Detent on request

MATERIAL CODE DESCRIPTION

Materials	112A	112A
Body	Steel	Steel
Trunnion ball	Steel	Steel
Ball seats	POM	POM
O-rings	NBR	NBR
Tmin / Tmax	-20°C / 100°C	-20°C / 100°C
Porting pattern	L=SB01	T=SB13
Type	3KH	4KH

GENERAL DIMENSIONS

Type	SW ₁	SW ₂	A	H ₁	H ₂	K	Lever
3/4KH-DN4	12	17	36	72	116	240	AI
3/4KH-DN6	12	17	36	72	116	240	AI
3/4KH-DN8	14	17	38	84	138	320	AI
3/4KH-DN10	14	17	38	84	138	320	AI
3/4KH-DN13	14	17	38	96	158	320	AI
3/4KH-DN16	14	17	38	96	158	320	AI
3/4KH-DN20	17	19	46	107	180	320	AI
3/4KH-DN25	17	19	46	115	210	320	AI
3/4KH-DN25/32	17	19	46	115	210	320	AI
3/4KH-DN25/40	17	19	46	115	210	320	AI

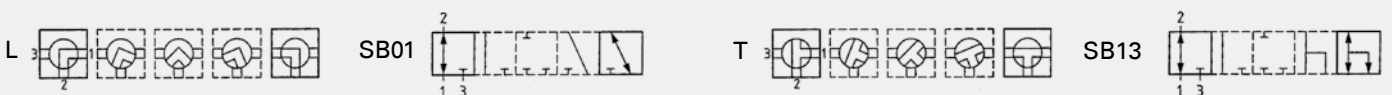

PORTING PATTERNS



Further porting patterns page 274 to 279

Multiway ball valve combinations Steel

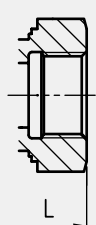
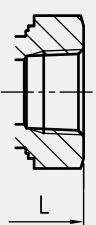
3KH, 4KH

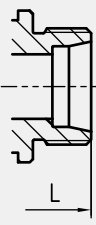
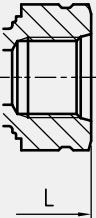
CONNECTION TYPE	DIMENSIONS			ORDER CODE PER MATERIAL COMBINATION		
	Type	L	Weight [Kg]	PN [bar]	3KH 112A L=SB01	4KH 112A T=SB13
	3/4KH-DN4-G1/8	100	3,50	500	38746	38747
	3/4KH-DN6-G1/4	100	3,50	500	38748	38749
	3/4KH-DN10-G3/8	115	6,00	500	38750	38751
	3/4KH-DN13-G1/2	136	10,20	400	38752	38753
	3/4KH-DN16-G5/8	139	10,20	400	38754	38755
	3/4KH-DN20-G3/4	154	14,00	315	38756	38757
	3/4KH-DN25-G1	172	17,50	315	38758	38759
	3/4KH-DN25/32-G1 1/4	180	18,00	315	38760	38761
3/4KH-DN25/40-G1 1/2	180	18,00	250	38762	38763	
	Type	L	Weight [Kg]	PN [bar]	3KH 112A L=SB01	4KH 112A T=SB13
	3/4KH-DN4-1/8"NPT	100	3,50	500	38764	38765
	3/4KH-DN6-1/4"NPT	100	3,50	500	38766	38767
	3/4KH-DN10-3/8"NPT	115	6,00	500	38768	38769
	3/4KH-DN13-1/2"NPT	160	10,20	400	38770	38771
	3/4KH-DN20-3/4"NPT	164	14,00	315	38772	38773
	3/4KH-DN25-1"NPT	186	17,50	315	38774	38775
	3/4KH-DN25/32-1 1/4"NPT	186	18,00	315	38776	38777
	3/4KH-DN25/40-1 1/2"NPT	186	18,00	250	38778	38779
	Type	L	Weight [Kg]	PN [bar]	3KH 112A L=SB01	4KH 112A T=SB13
	3/4KH-DN4-6L	105	3,50	500	38714	38715
	3/4KH-DN6-8L	105	3,50	500	38716	38717
	3/4KH-DN8-10L	114	6,00	500	38718	38719
	3/4KH-DN10-12L	114	6,00	500	38720	38721
	3/4KH-DN13-15L	137	9,80	400	38722	38723
	3/4KH-DN16-18L	137	9,80	400	38724	38725
	3/4KH-DN20-22L	152	13,80	315	38726	38727
	3/4KH-DN25-28L	166	16,50	315	38728	38729
3/4KH-DN25/32-35L	170	16,60	315	59592	59594	
	Type	L	Weight [Kg]	PN [bar]	3KH 112A L=SB01	4KH 112A T=SB13
	3/4KH-DN4-8S	105	3,50	500	38730	38731
	3/4KH-DN6-10S	105	3,50	500	38732	38733
	3/4KH-DN8-12S	116	6,00	500	38734	38735
	3/4KH-DN10-14S	120	6,00	500	38736	38737
	3/4KH-DN13-16S	141	9,80	400	38738	38739
	3/4KH-DN16-20S	145	9,80	400	38740	38741
	3/4KH-DN20-25S	160	13,80	315	38742	38743
	3/4KH-DN25-30S	176	16,50	315	38744	38745
3/4KH-DN25/32-38S	180	16,60	315	59596	59598	
	Type	L	Weight [Kg]	PN [bar]	3KH 112A L=SB01	4KH 112A T=SB13
	3/4KH-DN6-7/16"UNF	100	3,50	500	38780	38781
	3/4KH-DN10-9/16"UNF	115	6,00	500	38782	38783
	3/4KH-DN13-3/4"UNF	144	10,40	400	38784	38785
	3/4KH-DN20-1 1/16"UN	164	14,00	315	38786	38787
	3/4KH-DN25-1 5/16"UN	180	17,50	315	38788	38789

Please note the pressure ratings of the tube connections!

*Article usually in stock.